

Uniwersytet Przyrodniczy w Poznaniu
Wydział Technologii Drewna
Katedra Meblarstwa
 www.up.poznan.pl/km

CAX w przemyśle meblarskim

prof. dr hab. inż. JERZY SMARDZEWSKI

1

Wytwory natury



2

Venus paleolityńska – Kostienki (Ukraina) 19000 p.n.e.



3

Scara Brae – Szkocja 4500 p.n.e.



4

Tron Tutenchamona 1325 p.n.e.

DREWNO, ZŁOTA BLACHA, SREBRO, PASTA SZKLANA
 I PÓLSZACHETNE KAMIEŃ. WYSOKOŚĆ 102 CM,
 DŁUGOŚĆ 94 CM, SZEROKOŚĆ 80 CM



5

Grecja, klismos i thronos 430 – 50 p.n.e.



6

Georg Happlewhite 1794 r.



7

Fotel Barcelona, Ludwig Mies Van der Rohe 1927 r.



8

Eksport mebli mieszkaniowych [mln. euro]

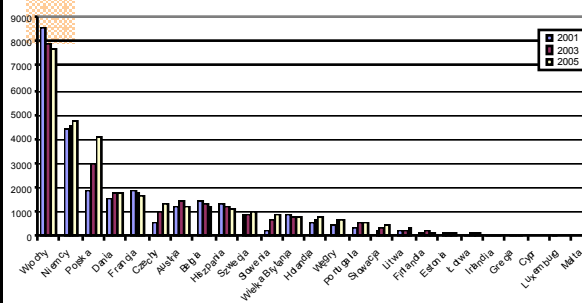

Źródło: Eurostat, 2006

9

Przemysł meblarski w Polsce

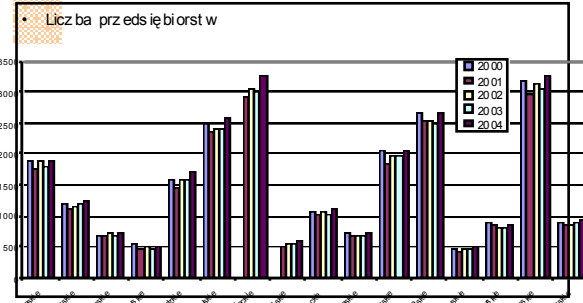

Źródło: Eurostat 2006

10

Zysk w projektowaniu nowych produktów

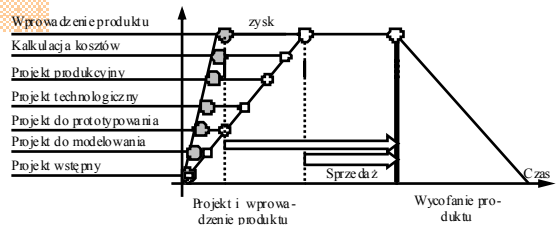

11

Metodyka projektowania mebli

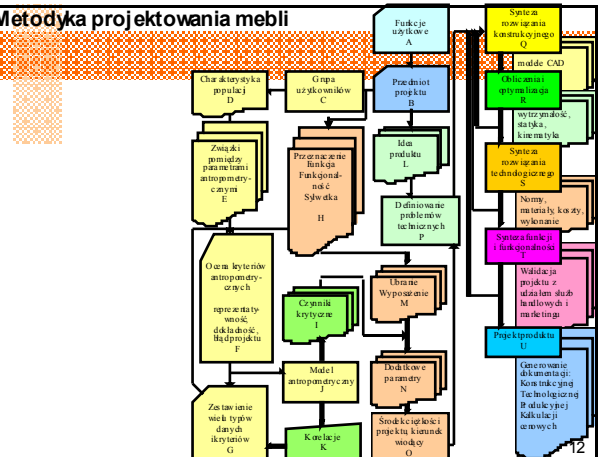

12

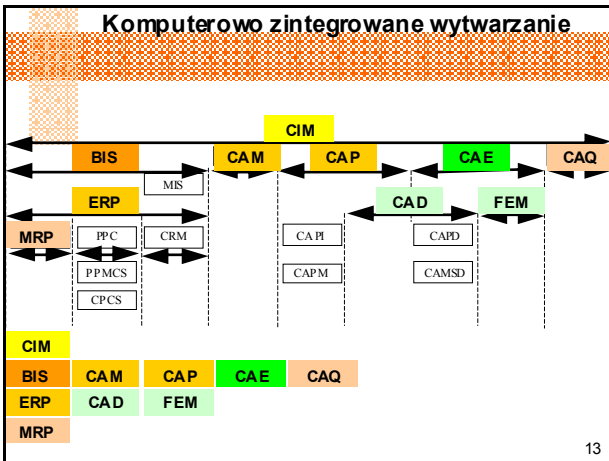

13

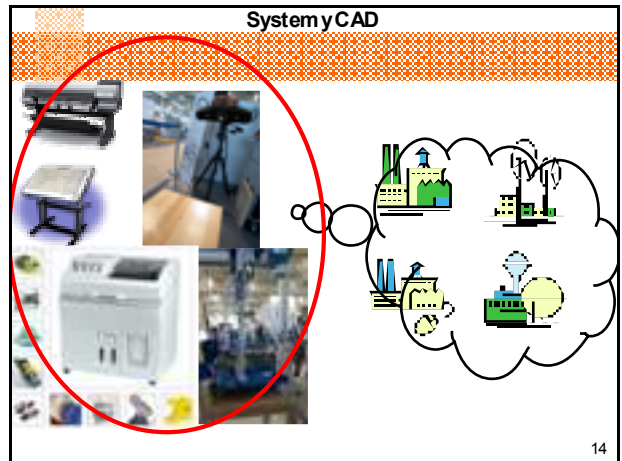

14



15



16

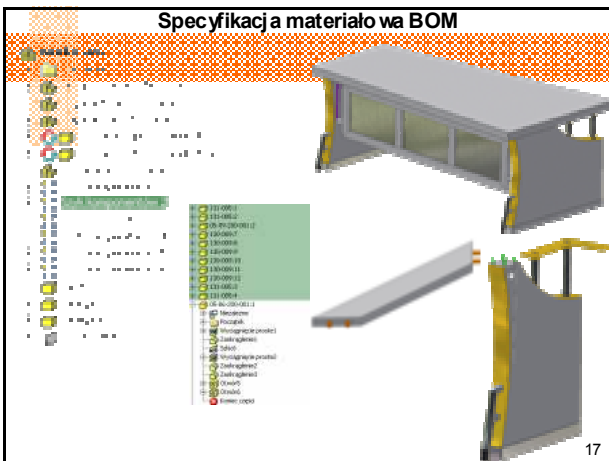

17

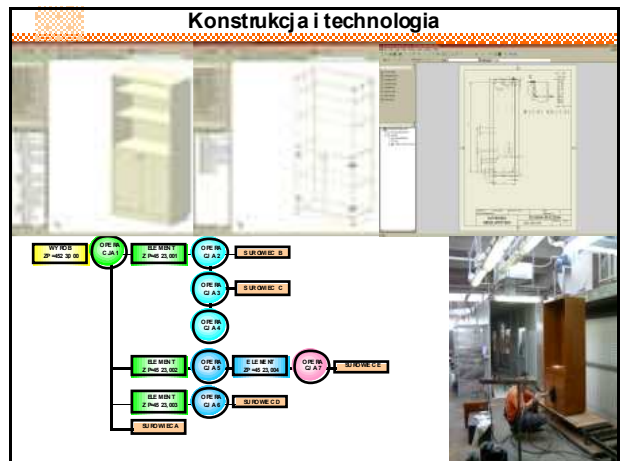

Więzy parametryzacja

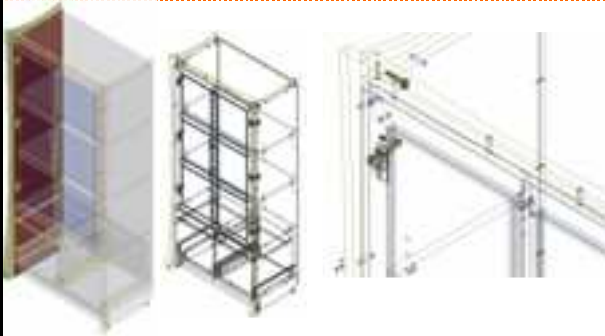

19

Systemy CAD – wersje produktów

Efekt parametryzacji wyrobów gotowych



20

Systemy CAD – ergonomia



21

Systemy CAD – ergonomia

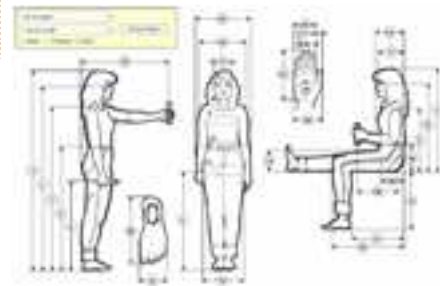

22

Systemy CAD – ergonomia

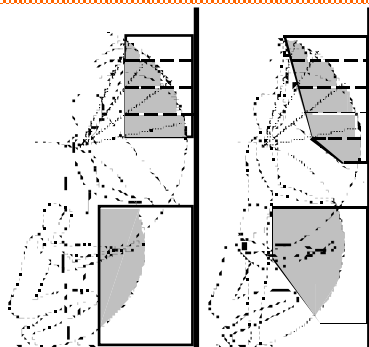

23

Systemy CAD – ergonomia



24

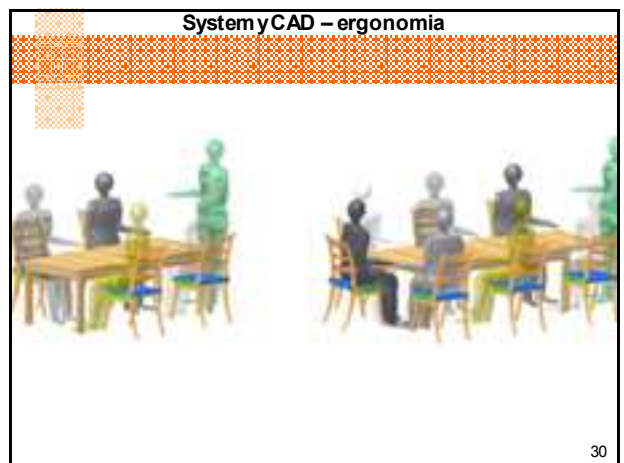
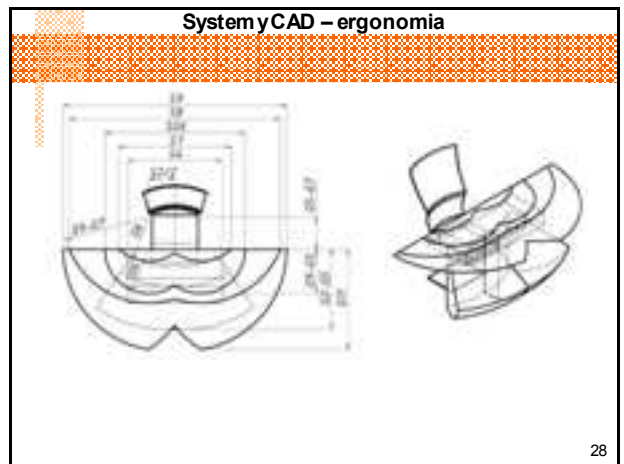
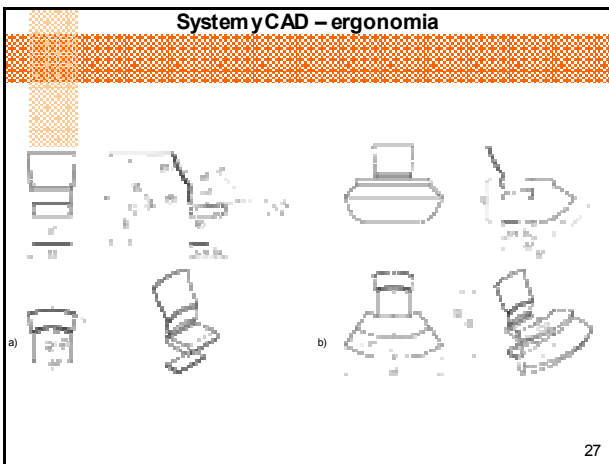
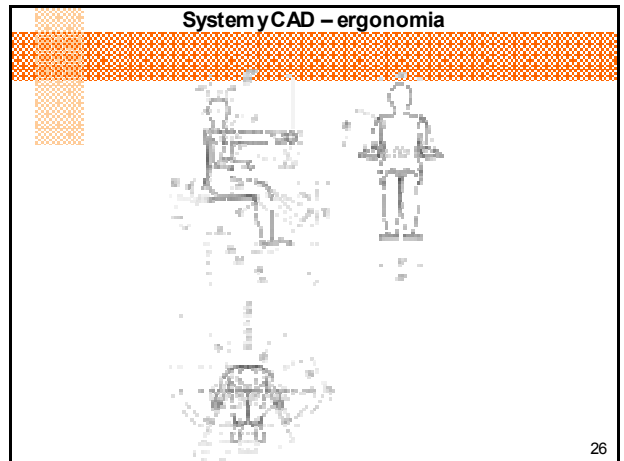
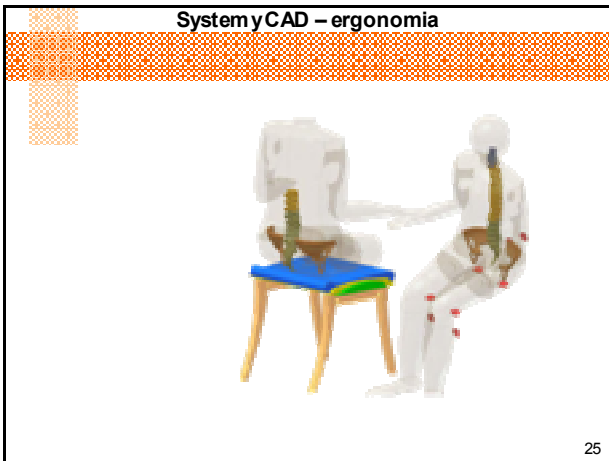

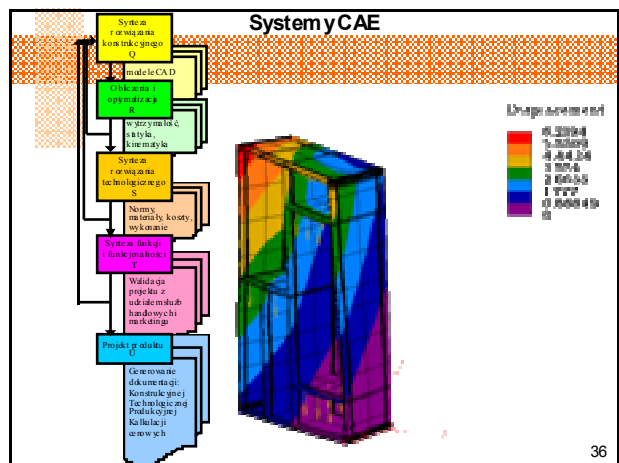
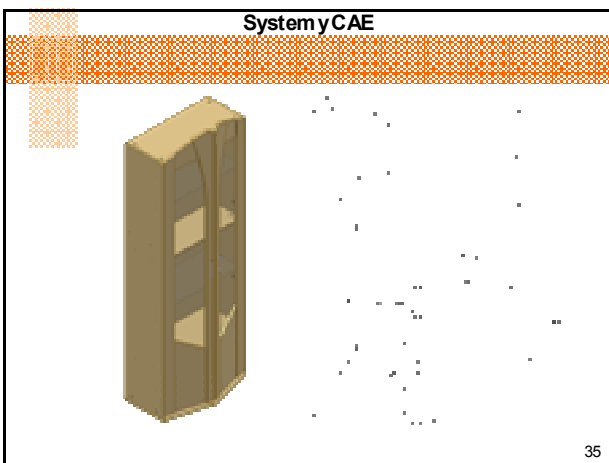
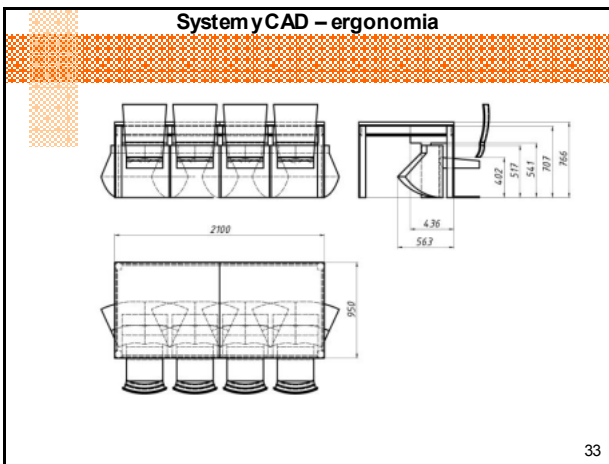
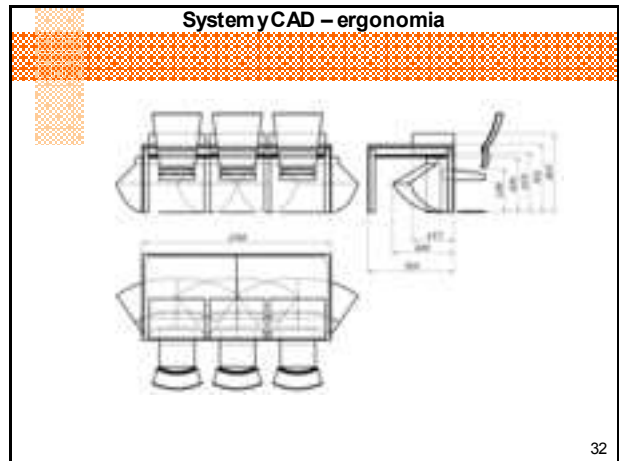
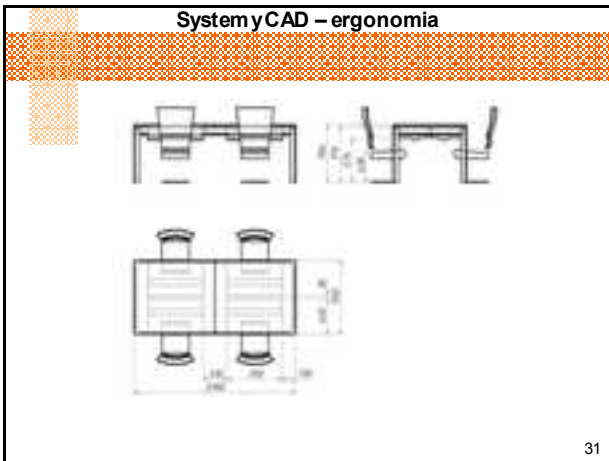

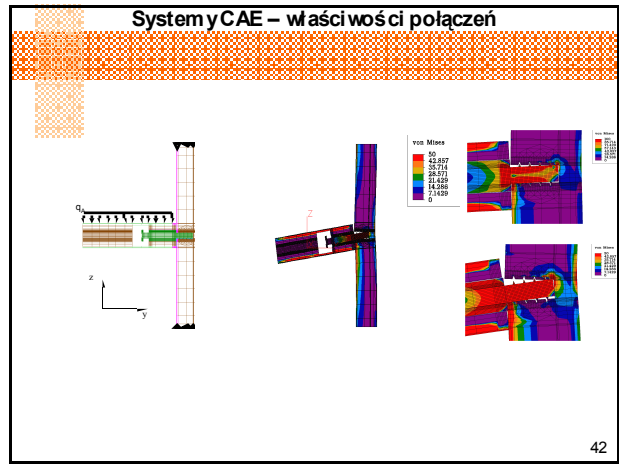
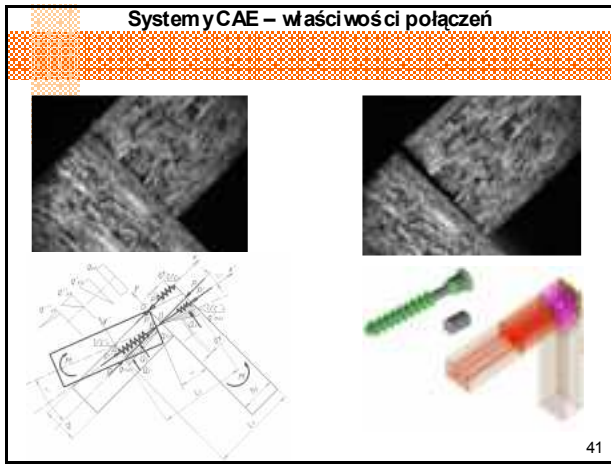
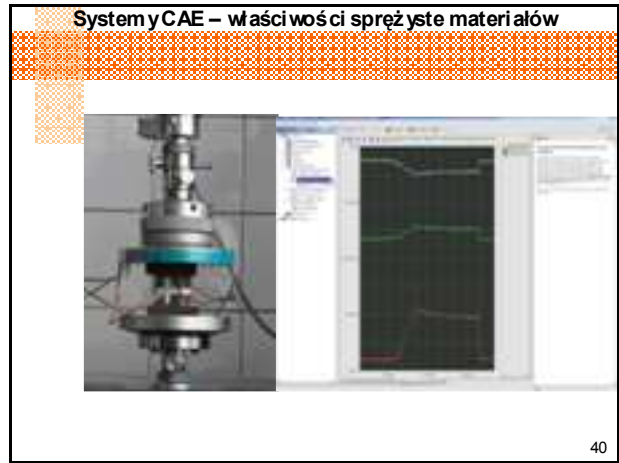
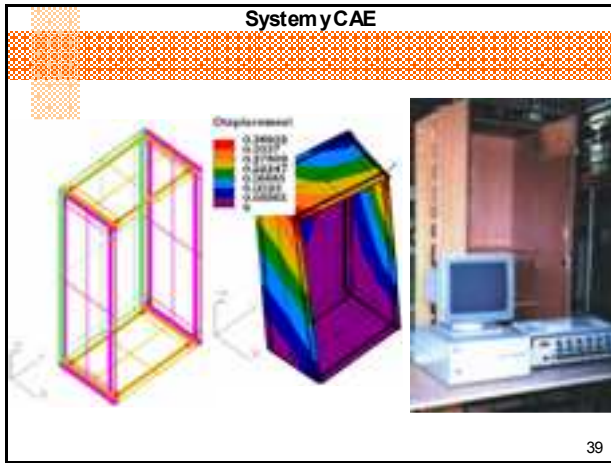
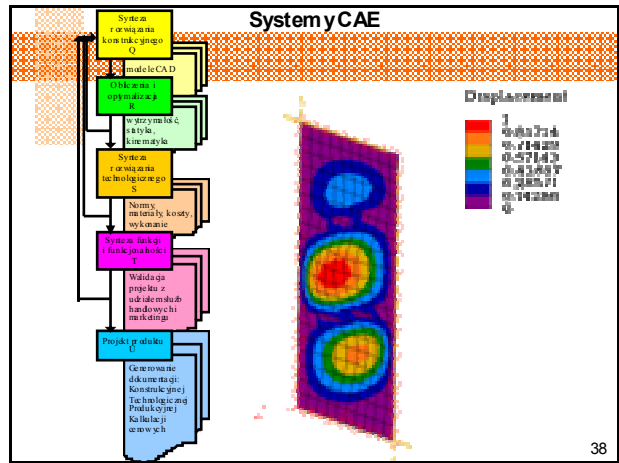
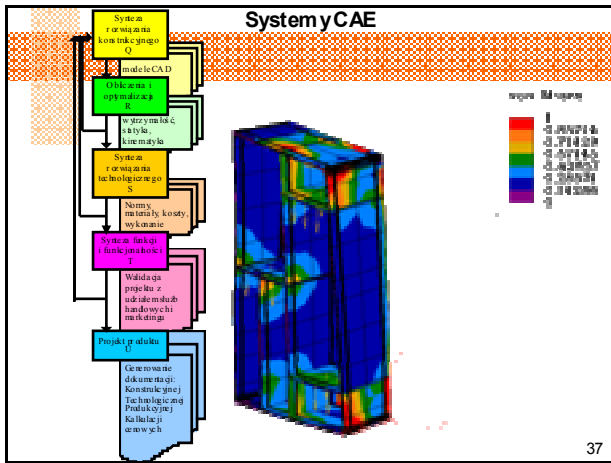

Systemy CAE – właściwości połączeń

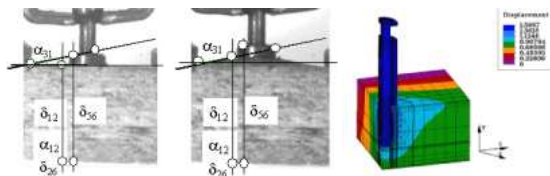

43

Systemy CAE – właściwości połączeń

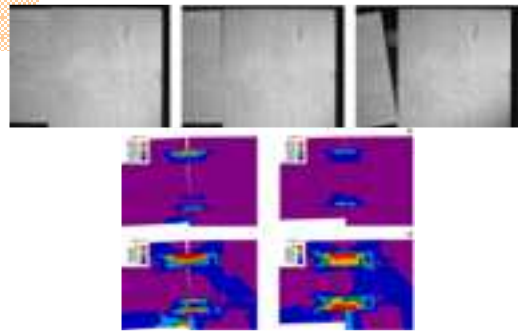

44

Badania atestacyjne



45

Systemy CAE

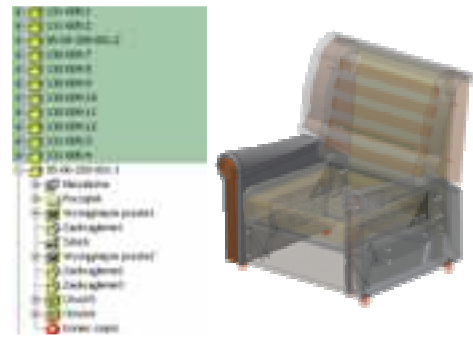

46

Systemy CAE

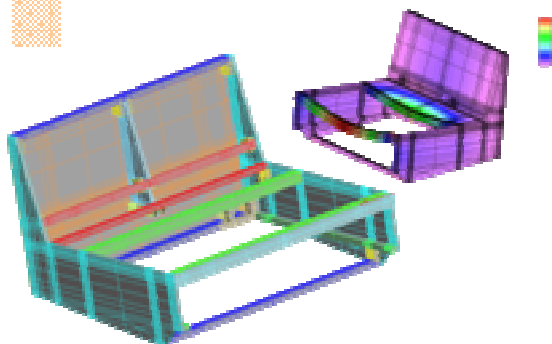

47

Systemy CAE



48

Badania atestacyjne



49

Systemy CAE



50

Systemy CAE



51

Systemy CAE

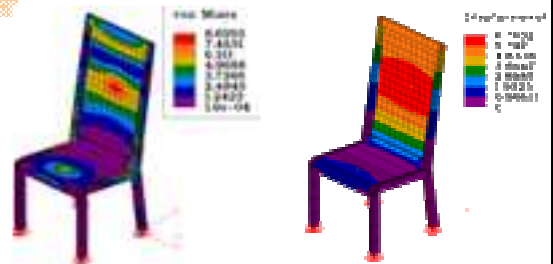

52

Systemy CAE

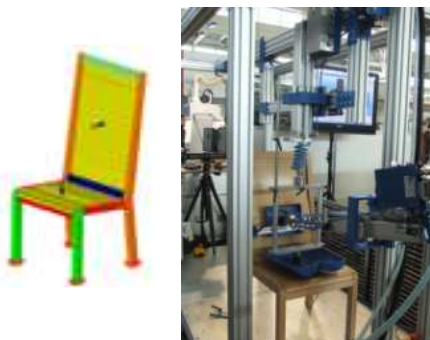

53

Systemy CAE

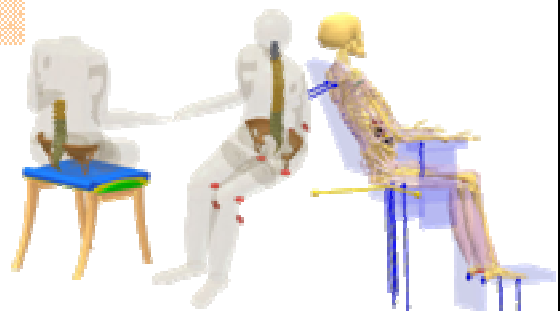

54

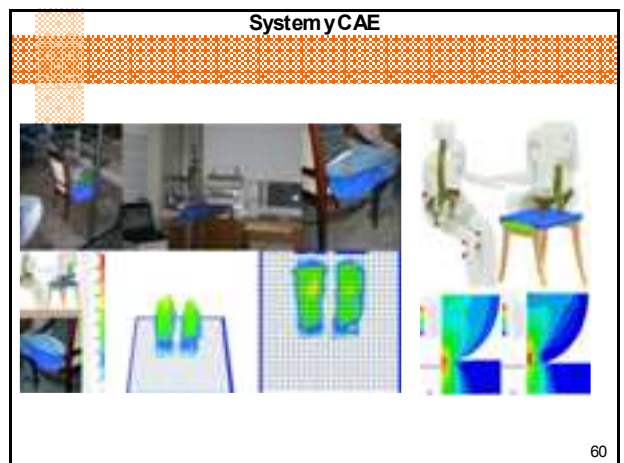
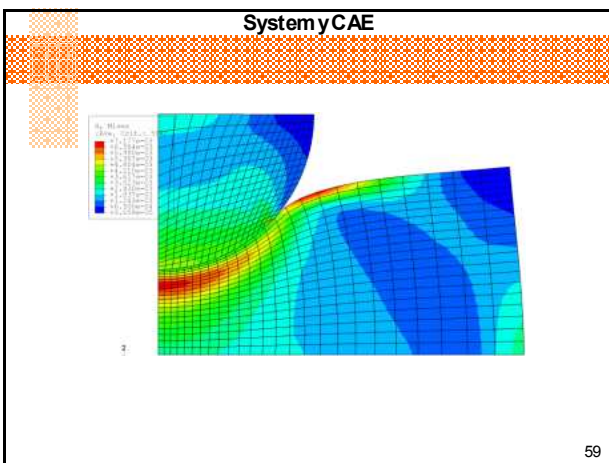
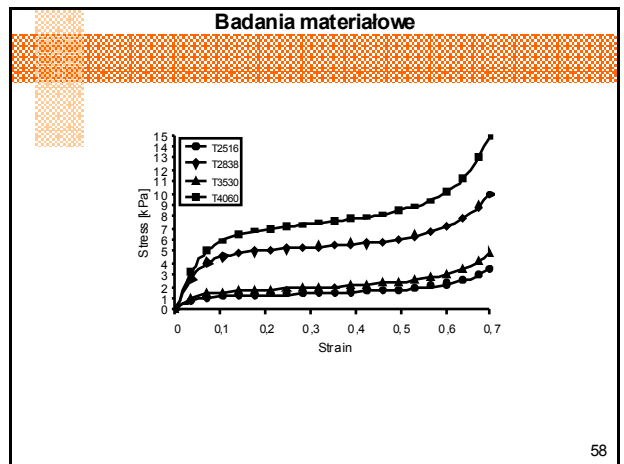
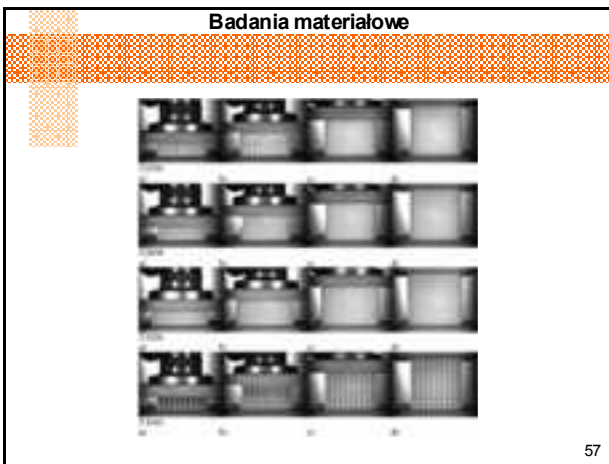
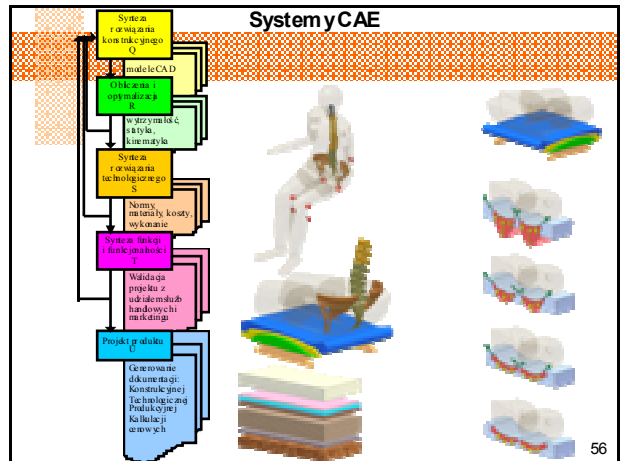
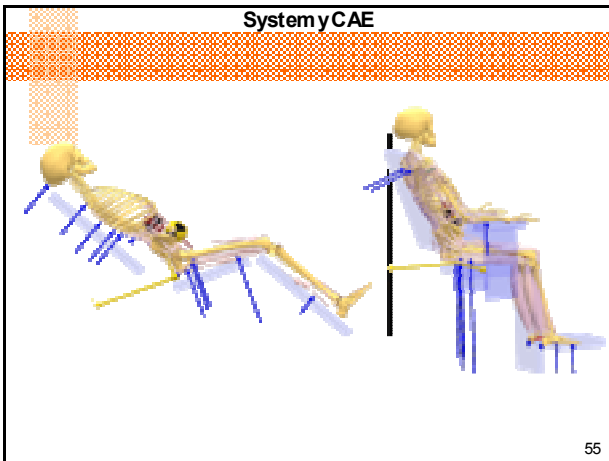

Systemy CAE



fot. www.reblomrak.com.pl

61

Systemy CAE

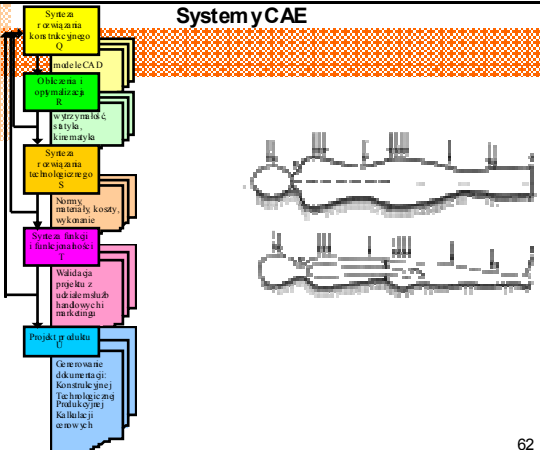

62

Systemy CAE

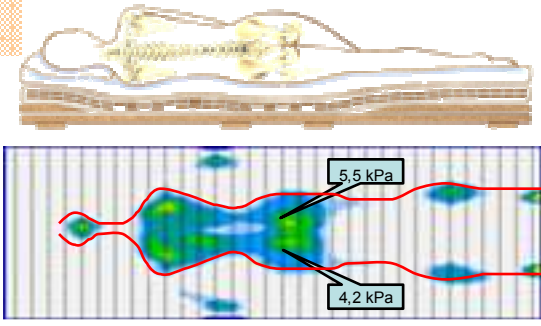

63

Systemy CAE

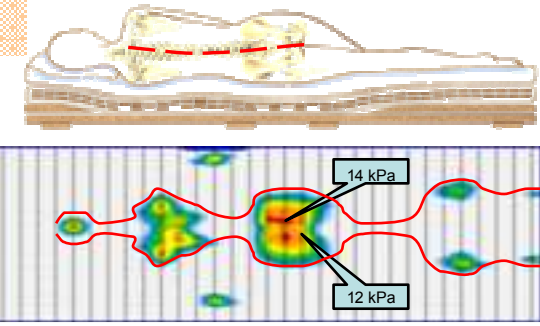

64

Systemy CAE

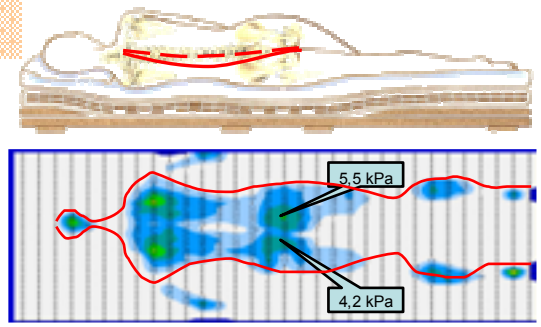

65

Systemy CAE



66

System y CAE

67

System y CAE

$$V = U_z - U_w$$

$$U_z = \frac{1}{2} P w(x, y)$$

$$U_w = \frac{1}{2} \int_0^a \int_0^b \left(q_x w(x, y) + M_x \frac{\partial^2 w}{\partial x^2} + M_y \frac{\partial^2 w}{\partial y^2} \right) dx dy$$

$$w_{\max} = \frac{2\sqrt{4} P D^2}{(D^2 k_1 + 32 k_g)} e^{-\beta z}$$

68

System y CAE

$$k = \frac{1}{\frac{4mn}{GJ^2 (R_2^m - R_1^m)} \int_0^{R_2} R^{m+2} dR}$$

69

System y CAE

70

System y CAE

Example of a beam model of finite elements for a dual conical spring

71

System y CAE

Example of deformation and subsidence of active coils in the dual conical spring model

72

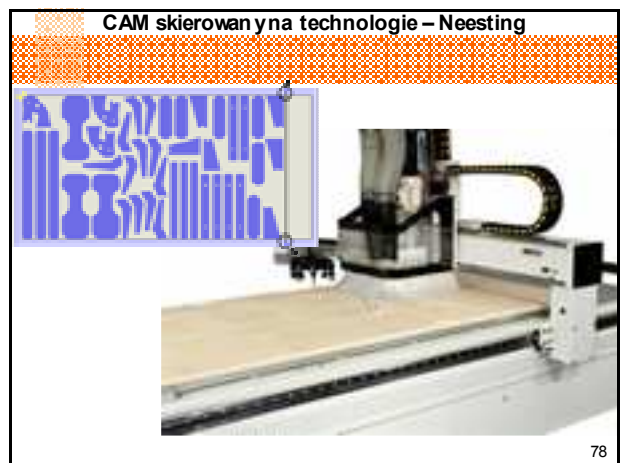
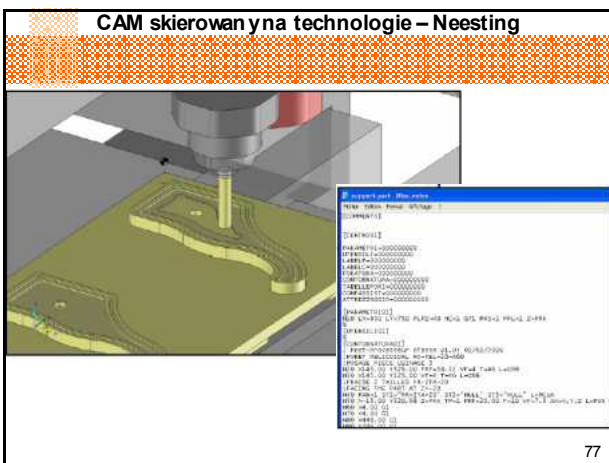
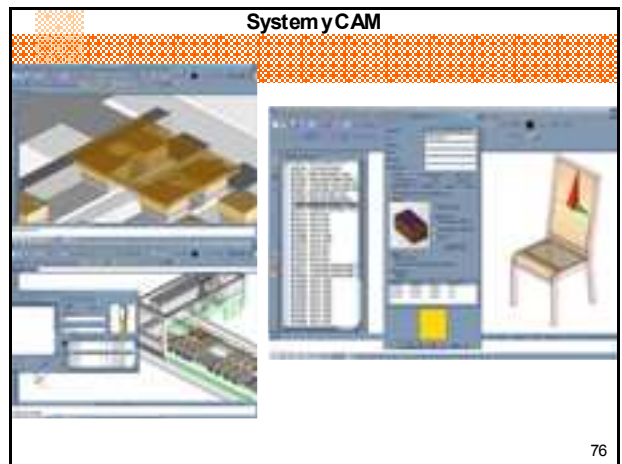
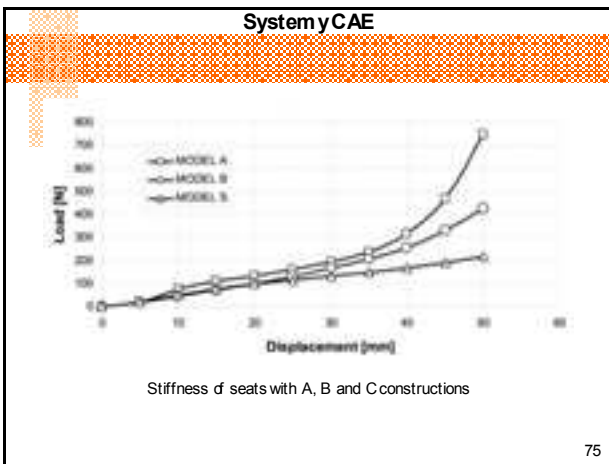
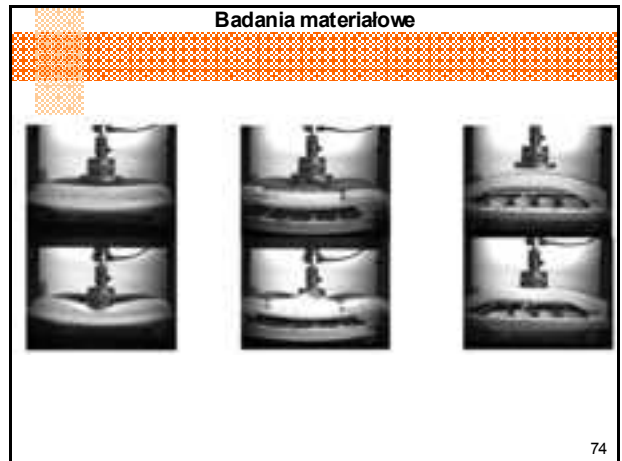
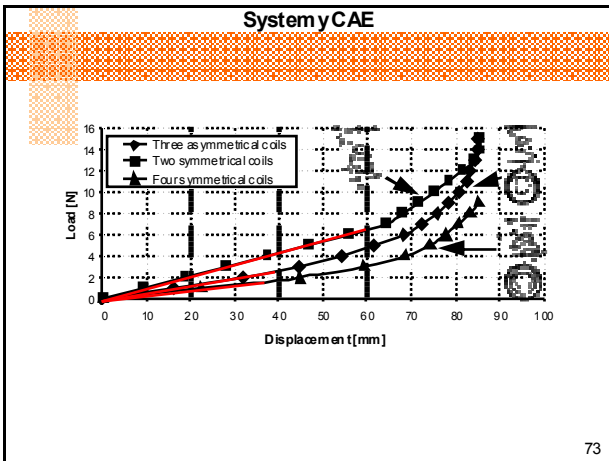

Interfejsy do programów optymalizujących rozkroje



79

Szablony dla rozkroju tkanin i skór

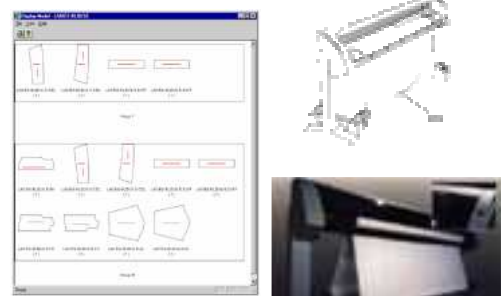

80

Szablony dla rozkroju tkanin i skór



81

Układy kroju tkanin

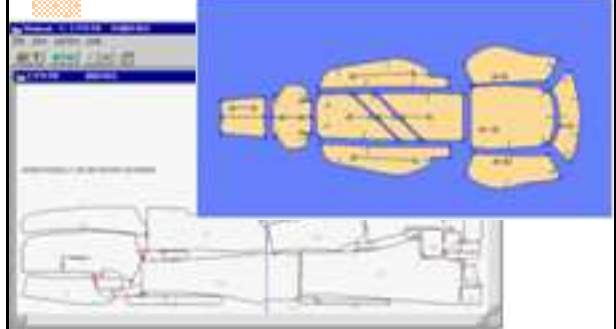

82

Układy kroju tkanin



83

Systemy CAM

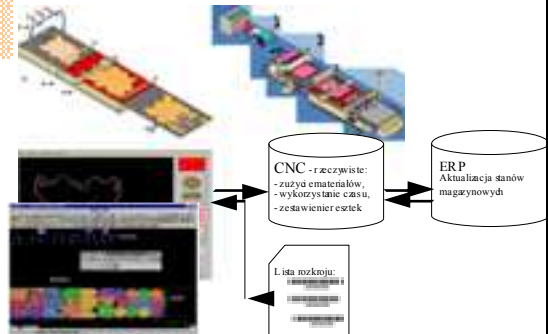

84

Lista części i zlecenia produkcyjne

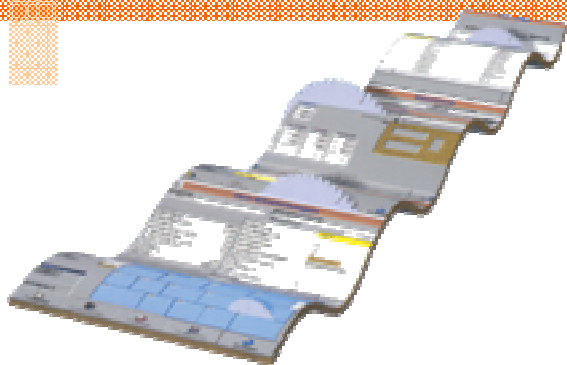

85

CAQ - Straty z powodu niedostatecznej jakości

Straty widoczne:

1. wady nienaprawialne,
2. poprawki,
3. zwroty od klientów.

Straty ukryte:

1. reklamacje klientów
2. roszczenia klientów
3. nadgodziny
4. zaległości płatnicze
5. zmarnowany wysiłek i nakłady
6. opóźnienia
7. zwiększone zapasy
8. nadmierny potencjał
9. utrata lojalności klientów
10. utrata potencjalnych klientów



86

DIC w ocenie jakości mebli

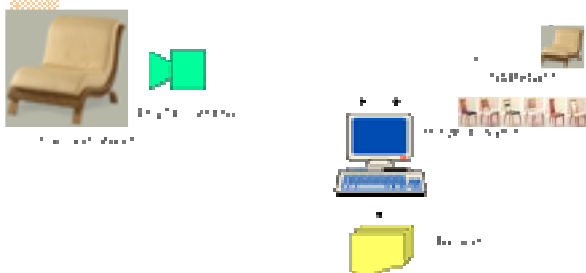

87

Plan kontroli jakości

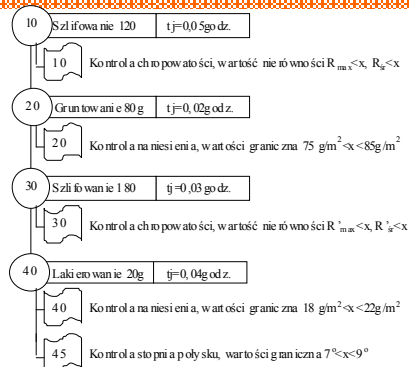

88

Systemy CAQ



89

Systemy CAQ



90

System yCAQ



91

System yCAQ

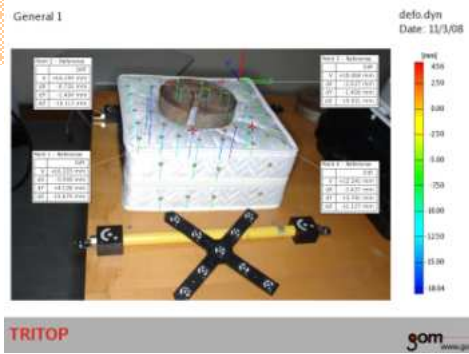

92

System yCAQ

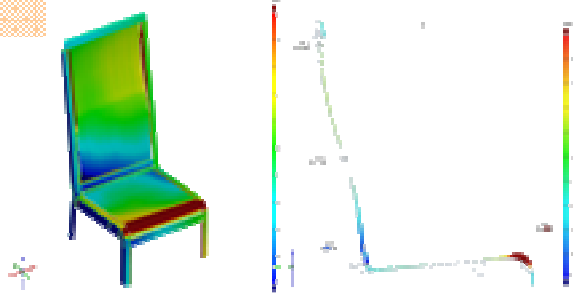

93

System yCAQ

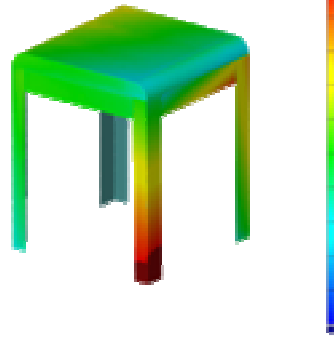

94

System yCAQ

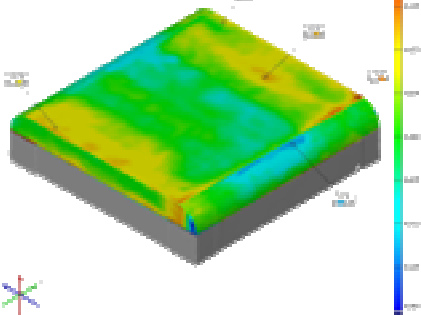

95

System yCAQ



96

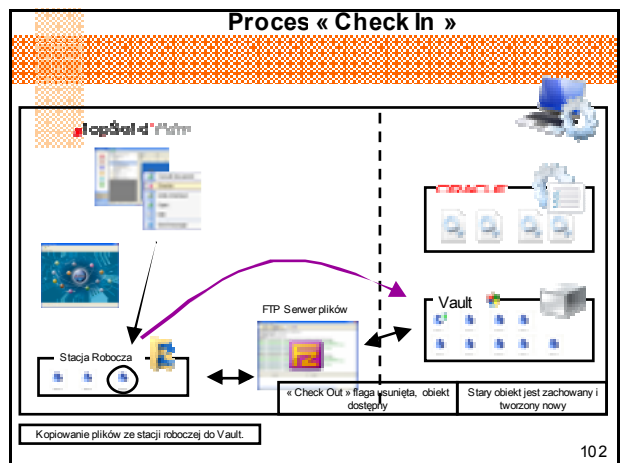
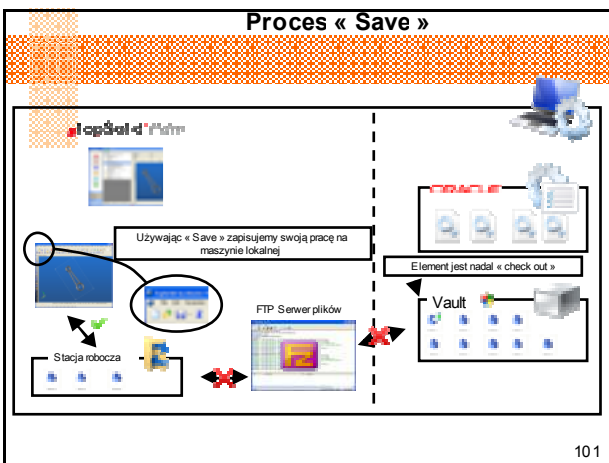
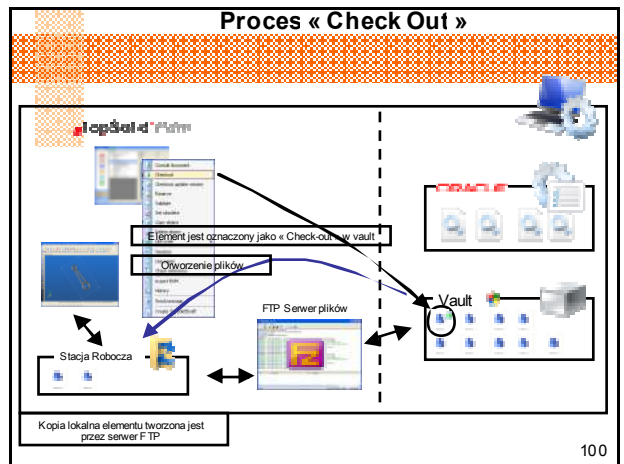
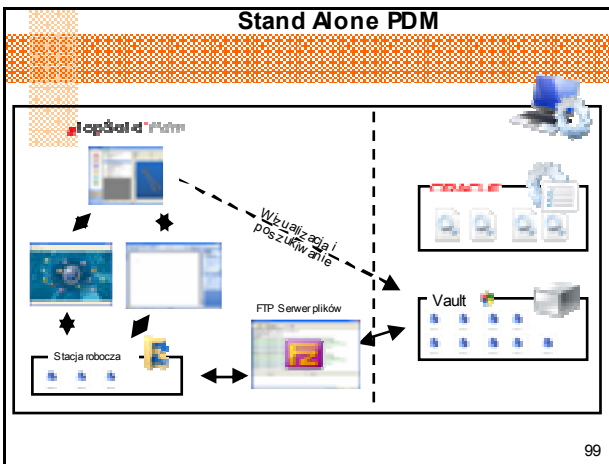
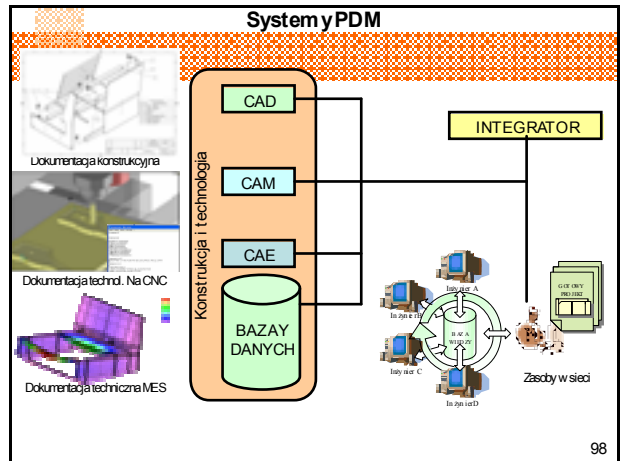
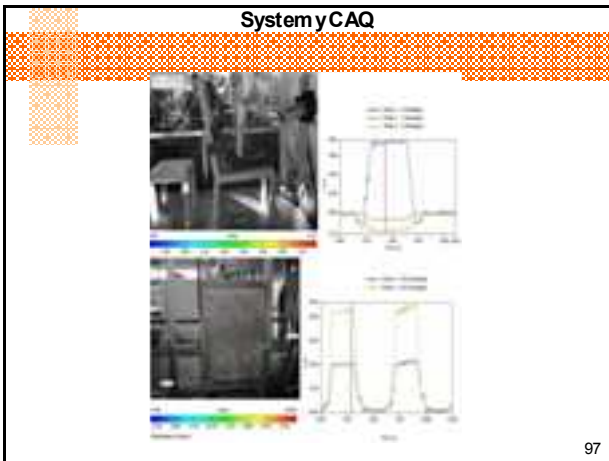

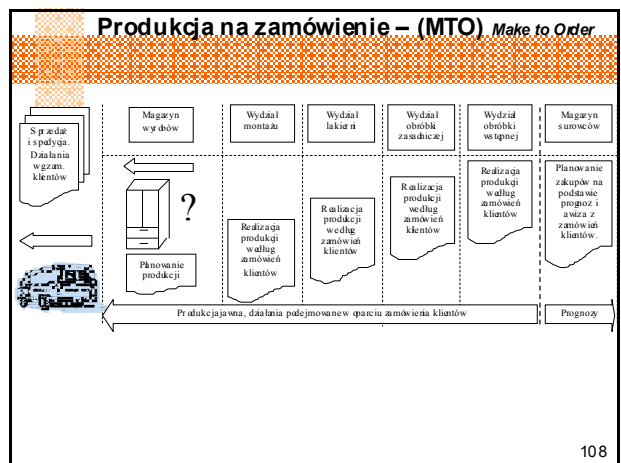
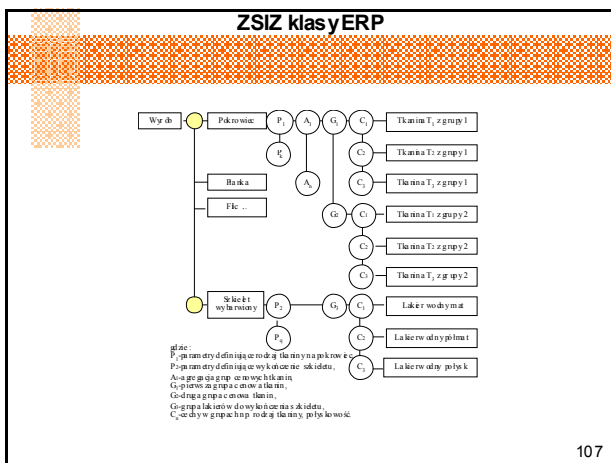
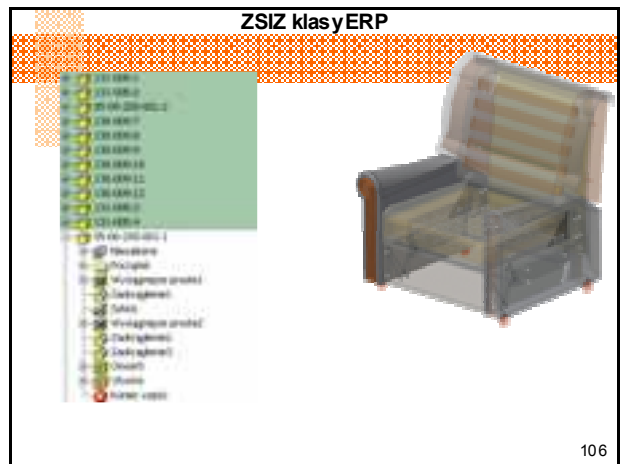
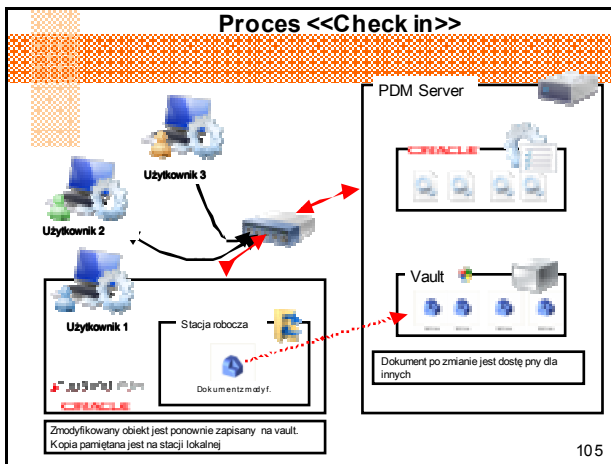
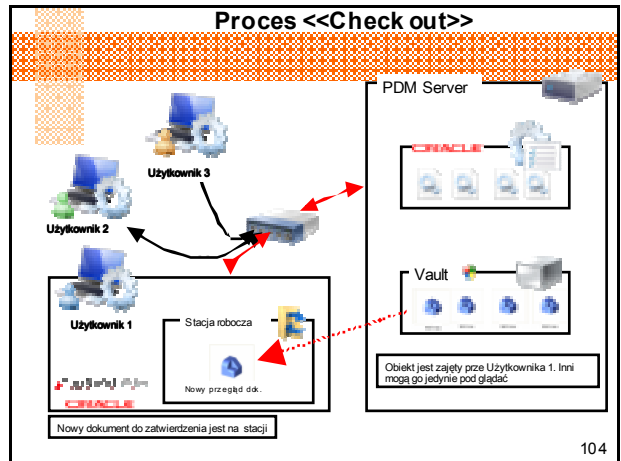
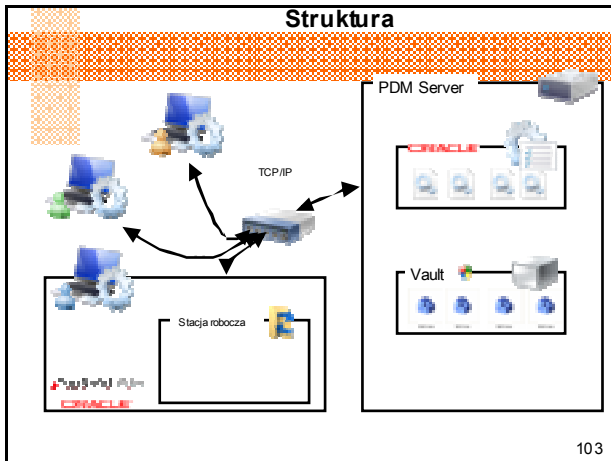

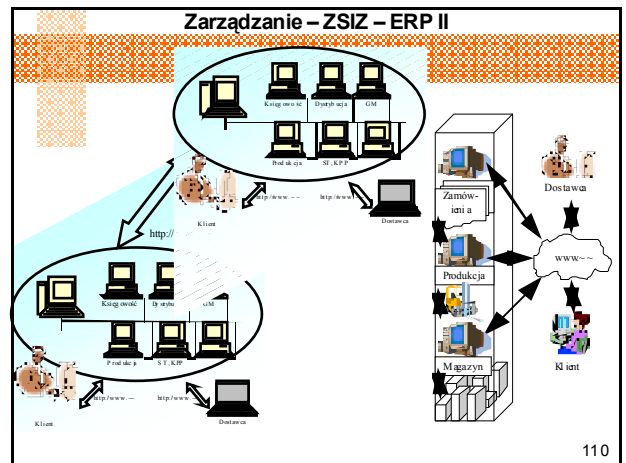
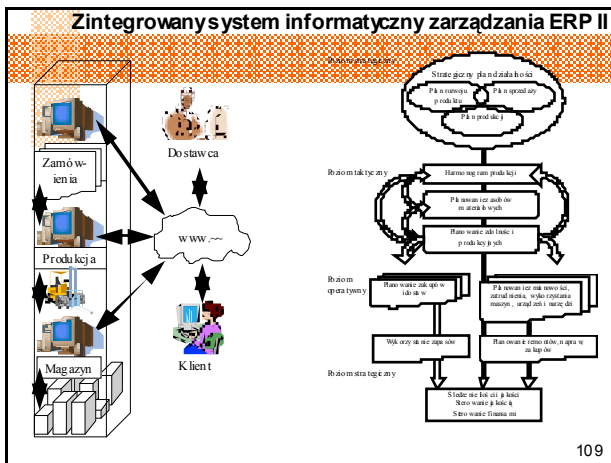



Dziękuję za życzliwą uwagę